

Electric Instrument Table

ST-26T ST-26H



ST-26T



ST-26H

Serving Your Vision



Electric Instrument Table

ST-26T/ST-26H

Wheelchair friendly Electric Instrument Table



Stylish and versatile medical grade electric instrument table, considering extreme safety with quiet operation for the most demanding medical environments.



Wheelchair friendly

The large underfoot space of ST-26 allows a patient in a wheelchair to be examined quickly and comfortably.

ST-26T with a T-shaped base has its column at the side of the table. ST-26H with a H-shaped base has its column at the center of the table.

*Wheelchairs with a front wheel outer width of 550mm or less are adaptable.

* It is recommended to fold up the footsteps of the wheelchair during examination.



Careful consideration of cable positioning

Access hole is strategically placed on the table top to pass a power cable through, and three auxiliary power outlets under the table top allow to power a full range of products without any need to run extra cables to a standard mains power supply.

The mains power cable for ST-26H extends from the side of the base eliminating interference with patient's feet.



Heavy load capability

With a load capacity of 80 kg, the ST-26H is well designed to withstand heavy equipment such as MT-325UD projection perimeter.

Large elevation stroke for all patient heights

Minimum height of the table is now approximately 100 mm lower than that of the previous model meaning small children can be easily examined. Without changing maximum height from the previous models, both ST-26T and ST-26H have a 300 mm elevation stroke to accommodate small to large patients sufficiently.

Space saving design

While the size of the table top for ST-26T remains the same as our previous model, the design change of the elevation unit achieved an overall width reduction of 14%, enabling ST-26T to be used efficiently in a limited space.



Various kinds of table tops

Various shapes of table tops for ST-26H are available to choose according to user requirements and applications.

*The optional 600mm x 400mm table top is recommended.

*Table top for our MT-325UD Perimeter is included as standard with MT-325UD.

* Please contact our sales department for full details on available table tops.



Specifications

Model name	ST-26T Electric Instrument Table	ST-26H Electric Instrument Table
Minimum height	560 mm	533 mm *Not including table top
Maximum height	860 mm	
Elevation stroke	300 mm	
Allowable load	30 kg	80 kg
Power	AC 100-240 V, 50/60 Hz	
Power consumption	950-2150 VA	
Auxiliary electrical outlets	3 outlets	
Weight	20.2 kg	15 kg
Size of base	604 (W) × 550 (D) mm	440 (W) × 650 (D) mm
Size of table top	600 (W) × 400 (D) mm	-



Dimensions

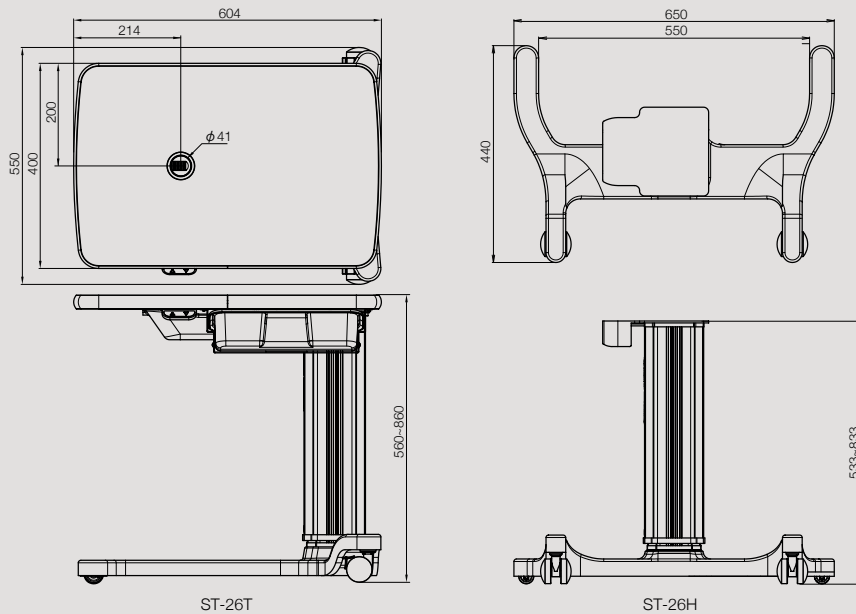

*The table top for ST-26H is optional.

 To ensure safe and correct handling please read the user manual before using.

- Description and appearance as detailed in this brochure may be subject to change as improvements are made to products.
- Colours as they appear in brochure photographs may be slightly different to actual products due to lighting conditions when photographs were taken, or print colours.



For The Americas, Asia-Pacific & Middle East
Takagi Seiko Co., Ltd
 330-2 Iwafune, Nakano-shi, Nagano-ken, 383-8585, Japan
 TEL : +81(0)269-22-4511(Switchboard) URL : <https://www.takagi-j.com>



Your local distributor



For Europe & Africa
Takagi Ophthalmic Instruments Europe Ltd
 Citylabs 1.0, Nelson Street, Manchester, M13 9NQ, UK
 TEL : +44 (0)161 273 6330 URL : <https://www.takagieurope.com>